

Topology diagram

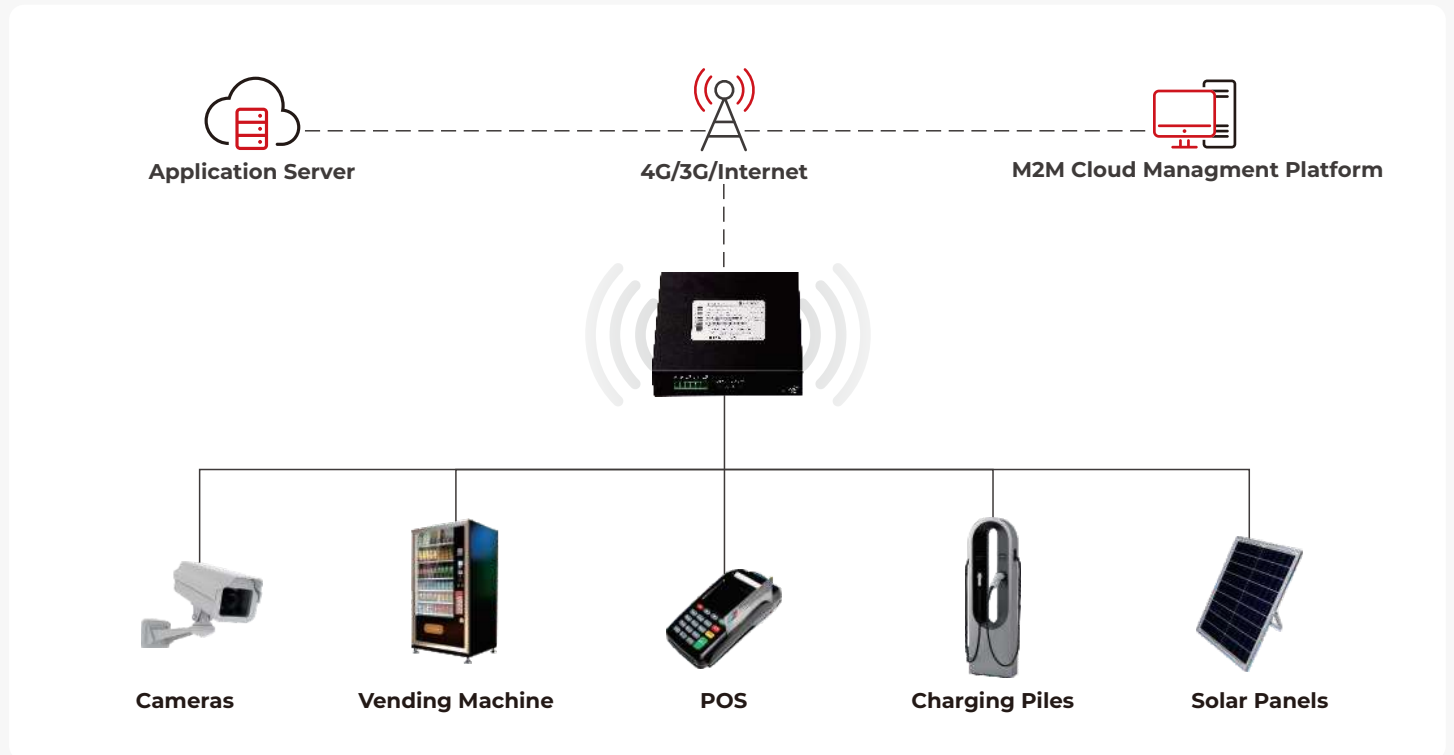

Automated Parcel Locker



Vending Machine



Smart Charging Pile



Solar Energy

Features



LTE Cat4/WiFi/Ethernet link-backup for Internet auto-failover



Advanced VPN protocols integrated, provide secure network



Support RS-232/RS-485



Support Hongdian Wedora RMS for cloud based management

Specification

Hardware			
CPU	MISP 24Kc 580MHz		
RAM	128MB	FLASH	16MB
Cellular Interface			
Modem	1 × LTE Cat4	SIM	1 × Mini SIM (2FF)
Number of Antennas	2	Connector	SMA-K
Ethernet Interface			
Number of Ports	2 × 10/100 Mbps, Ethernet	Configuration	2 × LAN or 1 × LAN + 1 × WAN
Wireless Interface			
Standards	802.11b/g/n, AP or station mode	Frequency Bands	2.4 GHz
Speed	150Mbps	Security	WEP, WPA, WPA2
Encryption	64/128 AES, TKIP	Antennas	1
Connector	SMA-K		
Software			
Auto Fail-over	Between: Cellular and WAN, Cellular and Wi-Fi (station mode), WAN and Wi-Fi (station mode)		
Network Protocols	PPP, PPPoE, TCP, UDP, DHCP, ICMP, NAT,HTTP, HTTPs, DNS, ARP, NTP, Telnet, SSH2, DDNS, etc.		
Routing	Static Routing, Policy routing, RIP, OSPF and BGP, etc		
Firewall	NAT, PAT, DMZ, Port Forward IP/Domain/MAC Filter, Access Control List		
VPN	PPTP/L2TP/GRE/IPSec/OpenVPN/DMVPN/WireGuard		
Remote Management	HTTP, Telnet, SSH, SMS, SNMP V1/V2/V3, SNMP TRAP, Hongdian Wedora Cloud Platform		
Power Supply and Consumption			
Connector	DC socket	Voltage Input	+5V~+36V DC
Power Consumption	Idle: 100mA@12V DC, Data transceiving: 350mA@12V DC		
Others			
Reset Button	Yes	Hardware Watchdog	Yes
LED Indicators	4 indicators for WiFi, RF, NET, SYS		
Physical Characteristics			
Ingress Protection	IP30	Housing & Weight	Metal, 300g
Dimension	99.7×98.8×23.4(mm)	Installations	Desktop, wall mounting
Operating Temperature	-30 ~ +75 °C	Storage Temperature	-40 ~ +85 °C
Relative Humidity	≤ 95%(no condensing)		

Appearance

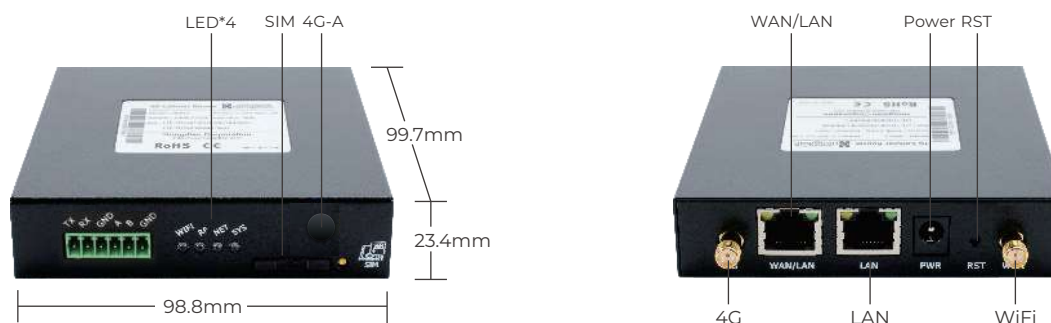







Ordering info

Part No.	Network	Frequencies	Interfaces			Certifications (*In progress)	Regions
			SIM	RJ45	WLAN		
H8951-L4-ENEA	LTE Cat 4	4G (LTE-FDD): B1/B3/B5/B7/B8/B20 4G (LTE-TDD): B38/B40/B41 3G: B1/B5/B8 2G: B3/B8				CE, RoHS, E-mark*	Europe, the Middle East, Africa, Korea, Thailand, India, Malaysia
H8951-L1-ENEA	LTE Cat 1						
H8951-L4-ENNA	LTE Cat 4	4G (LTE-FDD): B2/B4/B5/B12/B13/B25/B26 3G: B2/B4/B5				FCC, IC, PTCRB	North America
H8951-L1-ENNA	LTE Cat 1						
H8951-L4-ENSA	LTE Cat 4	4G (FDD-LTE): B1/B2/B3/B4/B5/B7/B8/B28 4G (LTE-TDD): B40 3G: B2/B3/B5/B8	1	2	Wi-Fi 4	RCM*, Anatel*	Oceania, South America
H8951-L4-ENJP	LTE Cat 4						
		4G (FDD-LTE): B1/B3/B8/B18/B19/B26/B28 4G (LTE-TDD): B39/B41 3G: B1/B6/B8/B19				VCCI*, JATE*, TELEC*	Japan

* For more detailed information about the frequency or any specific requirement, please contact your sales representative.

Packing list

 <p>Packing Box</p>	 <p>H8951 4G Cellular VPN Router</p>	 <p>4G Magnetic SMA Antenna *Other type antennas available</p>
 <p>Power Adaptor (EU type)</p>	 <p>RJ45 Cable</p>	 <p>Wi-Fi SMA Antenna</p>
		 <p>Installation Kit</p>